





05

| | |
|---|-----------------|
|  | Aluminium |
|  | 2000 mm |
|  | Stainless Steel |
|  | 4÷25 kg |

Option RC (7270000004)

Conductive rotating hook group.

*Option F

The balancer is equipped with a friction/brake which controls the rotation speed of the drum.

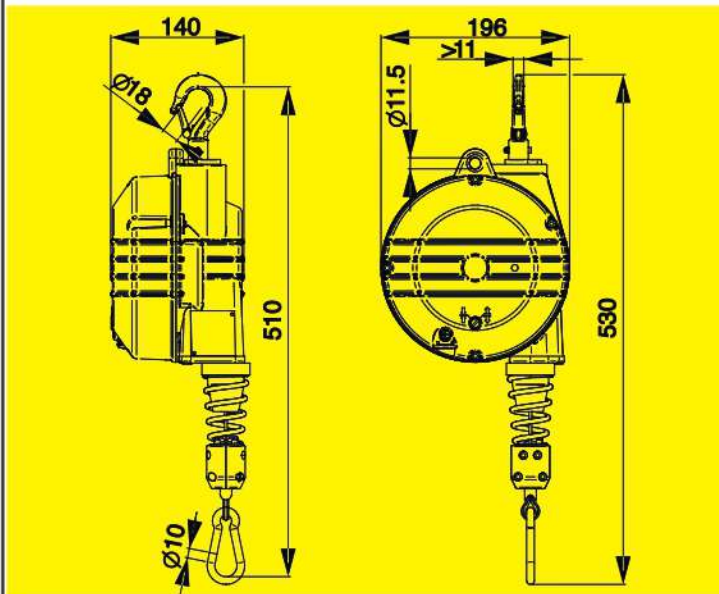

*This option is feasible when placing a new order while it is not possible to assemble this device on balancers already installed.



II 2G Ex h IIB T6 Gb (9354AX/9355AX)

II 2G Ex h IIA T6 Gb (9356AX÷9359AX)

II 2D Ex h IIIC T85°C Db

| Item | 9354AX | 9355AX | 9356AX | 9357AX | 9358AX | 9359AX |
|---|--------|--------|--------|--------|--------|--------|
|  ** | 4÷7 | 7÷10 | 10÷14 | 14÷18 | 18÷22 | 22÷25 |
|  | 4,94 | 5,30 | 5,67 | 6,26 | 5,89 | 6,53 |